

EXPLODED DRAWING A

Model No. NTEX02121-INT.2 R0621A

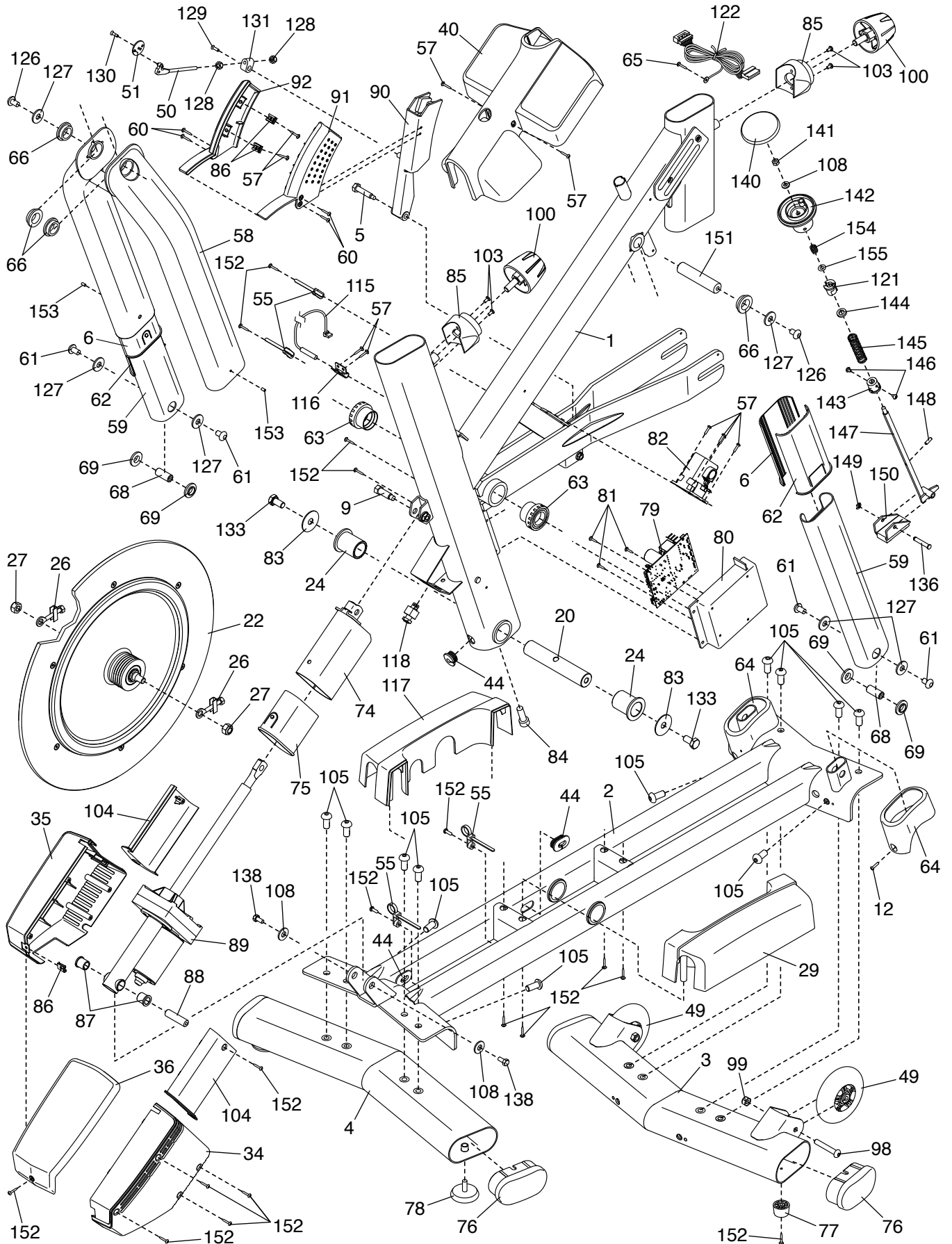

EXPLODED DRAWING B

Model No. NTEX02121-INT.2 R0621A

